









# GRADE 1 APRIL HOLIDAY HOMEWORK 2020

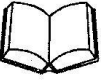

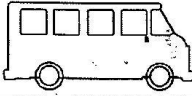
## ALL SUBJECTS

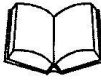
### MATHEMATICAL ACTIVITIES

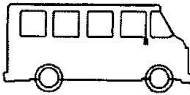
Match the objects

1.		
2.		
3.		
4.		
5.		

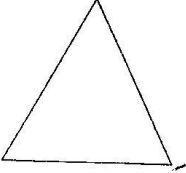
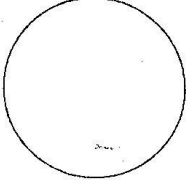
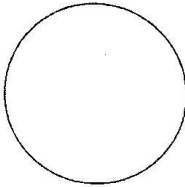
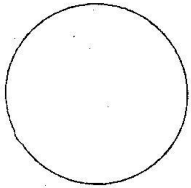
Colour the triangles red, circles blue, rectangles green

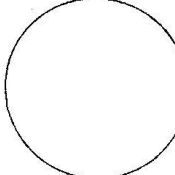
6.		7.		8.	
9.		10.		11.	

PARENT'S / GUARDIAN'S SIGN: \_\_\_\_\_

DATE: \_\_\_\_\_

# GRADE 1 APRIL HOLIDAY HOMEWORK 2020

## ALL SUBJECTS

12.

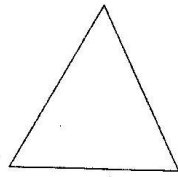

13.

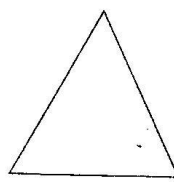

14.



15.

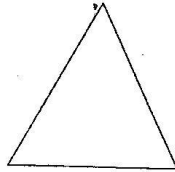

16.

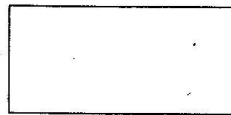

Write more than, less than or equal

17. These books are \_\_\_\_\_ the pencils.

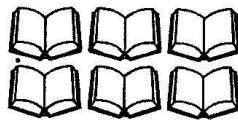

18. The circles are \_\_\_\_\_ the triangles.

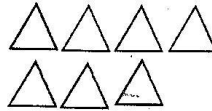
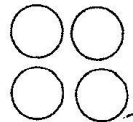

19. The girls are \_\_\_\_\_ the boys.

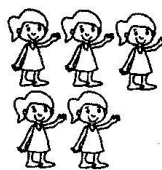

PARENT'S / GUARDIAN'S SIGN: \_\_\_\_\_

DATE: \_\_\_\_\_

# GRADE 1 APRIL HOLIDAY HOMEWORK 2020

## ALL SUBJECTS

20. The stars are \_\_\_\_\_ the squares

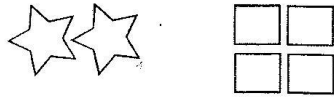

21. The boys are \_\_\_\_\_ the balls

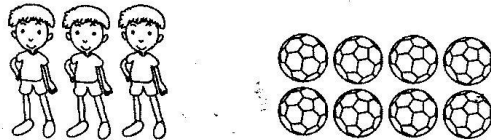

Write A or B

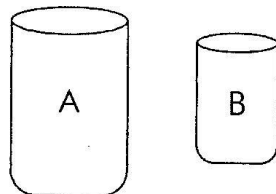

22. Bucket \_\_\_\_\_ is bigger

23. Bucket \_\_\_\_\_ is smaller.

Draw and colour the missing shapes

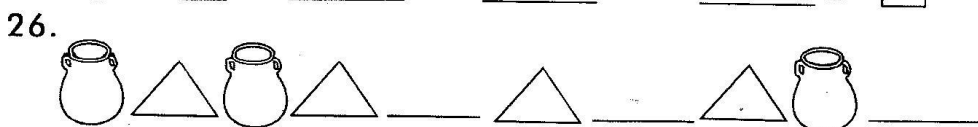
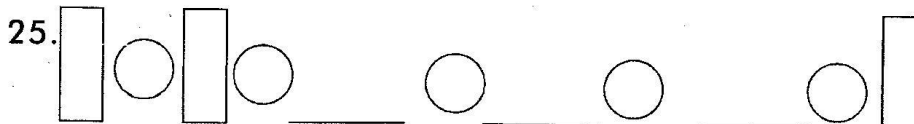
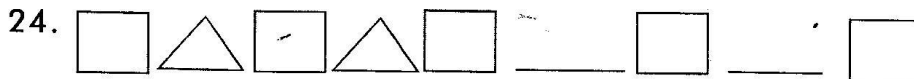

PARENT'S / GUARDIAN'S SIGN: \_\_\_\_\_

DATE: \_\_\_\_\_

# GRADE 1 APRIL HOLIDAY HOMEWORK 2020

## ALL SUBJECTS

### Count and write

27.

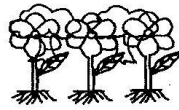

28.

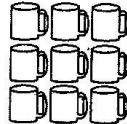

29.



30.



31.



32.



33.



34.

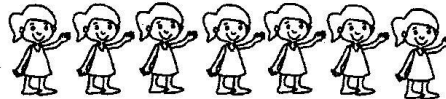

### Write the missing numbers

35. 3, 4, \_\_\_\_\_, 6, 7 \_\_\_\_\_, 9, 10

36. 11, 12, \_\_\_\_\_, 14, 15 \_\_\_\_\_, 17

37. 21, 22, 23, \_\_\_\_\_, 25, \_\_\_\_\_

38. 10, 11, \_\_\_\_\_, 13 \_\_\_\_\_, 15, \_\_\_\_\_

PARENT'S / GUARDIAN'S SIGN: \_\_\_\_\_

DATE: \_\_\_\_\_



# GRADE 1 APRIL HOLIDAY HOMEWORK 2020

## ALL SUBJECTS



### Write in words



39. 13 - \_\_\_\_\_
40. 11 - \_\_\_\_\_
41. 10 - \_\_\_\_\_
42. 7 - \_\_\_\_\_
43. 5 - \_\_\_\_\_

### Write the numbers

44. eighteen - \_\_\_\_\_
45. fifteen - \_\_\_\_\_
46. twelve - \_\_\_\_\_
47. sixteen - \_\_\_\_\_
48. twenty - \_\_\_\_\_
49. fourteen - \_\_\_\_\_
50. seventeen - \_\_\_\_\_

### Count and write

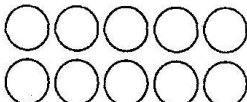
51.  +  = \_\_\_\_\_

52.  +  = \_\_\_\_\_

PARENT'S / GUARDIAN'S SIGN: \_\_\_\_\_

DATE: \_\_\_\_\_

# GRADE 1 APRIL HOLIDAY HOMEWORK 2020

## ALL SUBJECTS

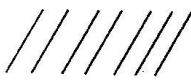
53.  +  = \_\_\_\_\_

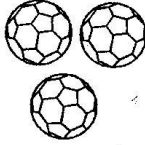
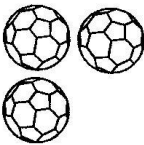
54.  +  = \_\_\_\_\_

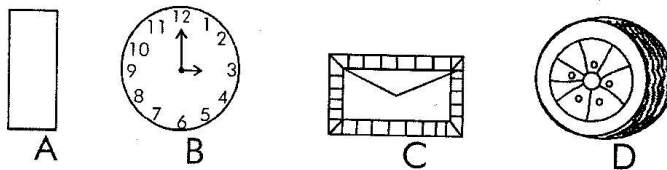

55.  +  = \_\_\_\_\_

56. Which objects have the same shape?



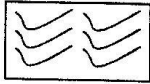

\_\_\_\_\_ and \_\_\_\_\_

Which group has more objects

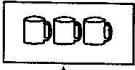
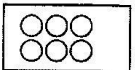
57.  A       B      \_\_\_\_\_

58.  A       B      \_\_\_\_\_

59.  A       B      \_\_\_\_\_

60.  A       B      \_\_\_\_\_

PARENT'S / GUARDIAN'S SIGN: \_\_\_\_\_

DATE: \_\_\_\_\_

# GRADE 1 APRIL HOLIDAY HOMEWORK 2020

## ALL SUBJECTS

Write equal or less

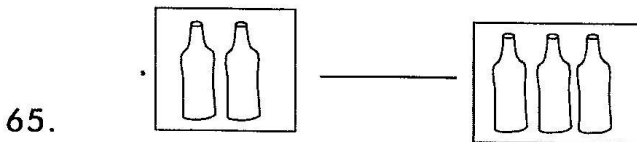
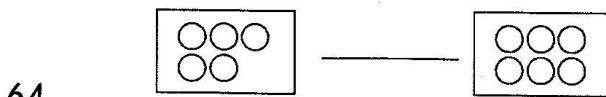
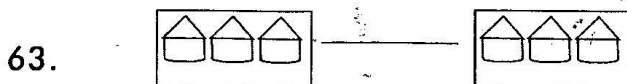
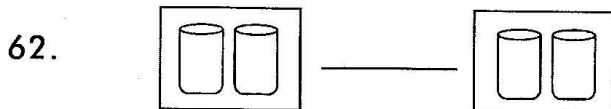

Draw balls and colour them

66. 10 = \_\_\_\_\_

67. 7 = \_\_\_\_\_

68. 4 = \_\_\_\_\_

69. 9 = \_\_\_\_\_

70. 7 = \_\_\_\_\_

PARENT'S /GUARDIAN'S SIGN: \_\_\_\_\_

DATE: \_\_\_\_\_

# GRADE 1 APRIL HOLIDAY HOMEWORK 2020

## ALL SUBJECTS

### Match objects and the numbers

71.	6	○ ○
72.	2	○
73.	8	○ ○ ○ ○ ○ ○
74.	1	○ ○ ○ ○ ○ ○ ○ ○

### Count in 2's forward and fill the missing numbers

75. 2, 4, \_\_\_\_\_, 8, 10
76. 6, 8, \_\_\_\_\_, 12, 14
77. 8, 10, \_\_\_\_\_, 14, 16
78. 12, 14, \_\_\_\_\_, 18, 20
79. 4, 6, \_\_\_\_\_, 10, 12
80. 10, 12, \_\_\_\_\_, 16, 18

### Count backwards and fill the missing numbers

81. 10, 9, \_\_\_\_\_, 7, 6
82. 12, 11, \_\_\_\_\_, 9, 8
83. 15, 14, \_\_\_\_\_, 12, 11

PARENT'S / GUARDIAN'S SIGN: \_\_\_\_\_

DATE: \_\_\_\_\_

# GRADE 1 APRIL HOLIDAY HOMEWORK 2020

## ALL SUBJECTS

---

84. 5, 4, \_\_\_\_\_, 2, 1

85. 18, 17, \_\_\_\_\_, 15, 14

Count in 10s forward and fill the missing numbers

86. 10, 20, \_\_\_\_\_, 40, 50

87. 50, 60, \_\_\_\_\_, 80, 90

88. 40, 50, \_\_\_\_\_, 70, 80

89. 30, 40, \_\_\_\_\_, 60, 70

90. 20, \_\_\_\_\_, \_\_\_\_\_

Match

91. Triangle



92. Square



93. Rectangle



94. Star



95. Circle

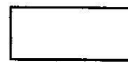

Oval



---

PARENT'S / GUARDIAN'S SIGN: \_\_\_\_\_

DATE: \_\_\_\_\_

# GRADE 1 APRIL HOLIDAY HOMEWORK 2020

## ALL SUBJECTS

Which one is smaller

96.

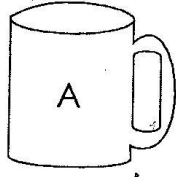

\_\_\_\_\_

97.

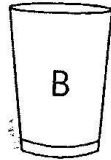

\_\_\_\_\_

98.

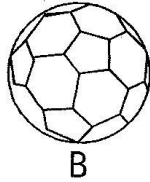

\_\_\_\_\_

99.



\_\_\_\_\_

100.

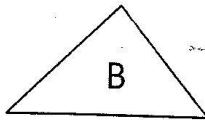

\_\_\_\_\_

PARENT'S / GUARDIAN'S SIGN: \_\_\_\_\_

DATE: \_\_\_\_\_

# GRADE 1 APRIL HOLIDAY HOMEWORK 2020

## ALL SUBJECTS

---

### ENGLISH ACTIVITIES

Write in small letters

1. MORNING - \_\_\_\_\_
2. MOTHER - \_\_\_\_\_
3. BROTHER - \_\_\_\_\_
4. SISTER - \_\_\_\_\_
5. FATHER - \_\_\_\_\_

Write in capital letter

6. Chair - \_\_\_\_\_
7. elephant - \_\_\_\_\_
8. glass - \_\_\_\_\_
9. puppy - \_\_\_\_\_
10. classroom - \_\_\_\_\_

Match the words with the correct questions

11. What is your \_\_\_\_\_ live
12. Do you have \_\_\_\_\_ boy
13. Where do you \_\_\_\_\_ a brother
14. Are you a girl or a \_\_\_\_\_ name

---

PARENT'S / GUARDIAN'S SIGN: \_\_\_\_\_ DATE: \_\_\_\_\_

# GRADE 1 APRIL HOLIDAY HOMEWORK 2020

## ALL SUBJECTS

Write four sentences using "I am"

15. \_\_\_\_\_
16. \_\_\_\_\_
17. \_\_\_\_\_
18. \_\_\_\_\_

Draw and colour

19. bag	20. book	21. pencil
22. ruler		

Write the plural

23. teacher - \_\_\_\_\_
24. pencil - \_\_\_\_\_

PARENT'S / GUARDIAN'S SIGN: \_\_\_\_\_ DATE: \_\_\_\_\_



# GRADE 1 APRIL HOLIDAY HOMEWORK 2020

## ALL SUBJECTS

---

25. book - \_\_\_\_\_
26. chair - \_\_\_\_\_
27. pupil - \_\_\_\_\_
28. paper - \_\_\_\_\_
29. duster - \_\_\_\_\_
30. chalk - \_\_\_\_\_

### Make sentences using the given words

31. cup - \_\_\_\_\_
32. sister - \_\_\_\_\_
33. book - \_\_\_\_\_
34. table - \_\_\_\_\_
35. ball - \_\_\_\_\_

### Use "is" , "am" or "are"

36. Grace and Mary \_\_\_\_\_ going to school.
37. I \_\_\_\_\_ singing.
38. They \_\_\_\_\_ cleaning the classroom.
39. It \_\_\_\_\_ Oloo's book.

---

PARENT'S / GUARDIAN'S SIGN: \_\_\_\_\_ DATE: \_\_\_\_\_

# GRADE 1 APRIL HOLIDAY HOMEWORK 2020

## ALL SUBJECTS

40. Grace and Mary \_\_\_\_\_ going to school.

41. John and Sam \_\_\_\_\_ eating.

### Complete the greetings

(fine, good morning, good evening, good afternoon,  
good night, welcome)

42. In the morning we say \_\_\_\_\_

43. In the afternoon we say \_\_\_\_\_

44. In the evening we say \_\_\_\_\_

45. At night we say \_\_\_\_\_

46. When someone says thank you, you say \_\_\_\_\_

47. How do you do? I am \_\_\_\_\_

### Write the correct answer

48. My name is \_\_\_\_\_

49. I am a \_\_\_\_\_ (boy, girl)

50. I am in grade \_\_\_\_\_

51. I am \_\_\_\_\_ years old.

52. My friend is called \_\_\_\_\_

PARENT'S / GUARDIAN'S SIGN: \_\_\_\_\_

DATE: \_\_\_\_\_

# GRADE 1 APRIL HOLIDAY HOMEWORK 2020

## ALL SUBJECTS

53. My school is called \_\_\_\_\_ primary school

Write "male" or "female"

54. father - \_\_\_\_\_

55. wife - \_\_\_\_\_

56. husband - \_\_\_\_\_

57. son - \_\_\_\_\_

58. sister - \_\_\_\_\_

59. uncle - \_\_\_\_\_

60. aunt - \_\_\_\_\_

Use "he" or "she"

61. \_\_\_\_\_ is my mother.

62. \_\_\_\_\_ is my father.

63. \_\_\_\_\_ is my brother.

64. \_\_\_\_\_ is my grandmother

65. \_\_\_\_\_ is called Mark.

66. \_\_\_\_\_ is called Michelle.

PARENT'S / GUARDIAN'S SIGN: \_\_\_\_\_ DATE: \_\_\_\_\_

# GRADE 1 APRIL HOLIDAY HOMEWORK 2020

## ALL SUBJECTS

Draw and colour

67. father	68. mother	69. brother
70. sister	71. myself	

Use the correct pronoun  
"he" "she" or "it"

72. My brother is tall.  
\_\_\_\_\_ is tall.

73. The cat is drinking milk.  
\_\_\_\_\_ is drinking milk.

74. Bob is my dog.  
\_\_\_\_\_ is my dog.

75. My mother is cooking.  
\_\_\_\_\_ is cooking.

PARENT'S / GUARDIAN'S SIGN: \_\_\_\_\_

DATE: \_\_\_\_\_

# GRADE 1 APRIL HOLIDAY HOMEWORK 2020

## ALL SUBJECTS

Write the words correctly

76. blate \_\_\_\_\_

77. lagss \_\_\_\_\_

Find the following words in the puzzle

c	u	p	c	k	m	x	y	a	c
h	x	y	h	m	o	t	h	e	r
o	c	f	a	t	h	e	r	x	y
u	c	u	i	d	h	x	y	c	z
s	c	d	r	s	i	s	t	e	r
e	c	r	o	t	h	e	r	y	d

78. father  
79. mother  
80. cup  
81. house  
82. chair  
83. sister  
84. brother

Add "-s" at the end of a doing word.

85. The boy run fast. \_\_\_\_\_

86. The girl play after school. \_\_\_\_\_

87. Everybody take a birth. \_\_\_\_\_

PARENT'S / GUARDIAN'S SIGN: \_\_\_\_\_

DATE: \_\_\_\_\_

# GRADE 1 APRIL HOLIDAY HOMEWORK 2020

## ALL SUBJECTS

Write the words three times

88. tells \_\_\_\_\_

89. talks \_\_\_\_\_

90. eats \_\_\_\_\_

Make words from the box

s	t	l
a	i	m
m	e	i

91. \_\_\_\_\_

92. \_\_\_\_\_

93. \_\_\_\_\_

94. \_\_\_\_\_

Use "is" or "are"

95. This \_\_\_\_\_ my pencil.

96. These \_\_\_\_\_ my books.

97. They \_\_\_\_\_ mopping.

98. Jane and Sam \_\_\_\_\_ eating.

99. This girl \_\_\_\_\_ clean.

100. The books \_\_\_\_\_ covered.

PARENT'S / GUARDIAN'S SIGN: \_\_\_\_\_

DATE: \_\_\_\_\_

# GRADE 1 APRIL HOLIDAY HOMEWORK 2020

## ALL SUBJECTS

### READING

#### Read the words

- |               |               |
|---------------|---------------|
| 1 . big       | 2 3 . wall    |
| 2 . cub       | 2 4 . top     |
| 3 . pig       | 2 5 . broom   |
| 4 dog         | 2 6 sister    |
| 5 . door      | 2 7 . duck    |
| 6 . this      | 2 8 . jam     |
| 7 . thin      | 2 9 . mud     |
| 8 . book      | 3 0 . chair   |
| 9 . teacher   | 3 1 . glass   |
| 1 0 . here    | 3 2 . beat    |
| 1 1 . class   | 3 3 . girl    |
| 1 2 . kid     | 3 4 . water   |
| 1 3 . sheep   | 3 5 . school  |
| 1 4 reed      | 3 6 these     |
| 1 5 . moon    | 3 7 . mother  |
| 1 6 . table   | 3 8 . morning |
| 1 7 . look    | 3 9 . food    |
| 1 8 . her     | 4 0 . pan     |
| 1 9 . green   | 4 1 . three   |
| 2 0 . jug     | 4 2 . desk    |
| 2 1 . chop    | 4 3 . ball    |
| 2 2 . brother | 4 4 . chop    |

PARENT'S / GUARDIAN'S SIGN: \_\_\_\_\_ DATE: \_\_\_\_\_

# GRADE 1 APRIL HOLIDAY HOMEWORK 2020

## ALL SUBJECTS

- |             |            |
|-------------|------------|
| 4 5 . tin   | 5 3. doll  |
| 4 6. friend | 5 4. him   |
| 4 7. house  | 5 5 . leg  |
| 4 8 hand    | 5 6. good  |
| 4 9. sun    | 5 7. his   |
| 5 0. she    | 5 8 mother |
| 5 1. spoon  | 5 9. two   |
| 5 2. father | 6 0. stool |

I am in grade one. I am six years old. My friend is called Monica. Monica is a girl. She is in grade one. Monica and I play together, we go to school together too. She is a good friend.

---

**PARENT'S / GUARDIAN'S SIGN:** \_\_\_\_\_

**DATE:** \_\_\_\_\_









# GRADE 1 APRIL HOLIDAY HOMEWORK 2020

## ALL SUBJECTS

### HYGIENE AND NUTRITION ACTIVITIES

1. Healthy \_\_\_\_\_ are things we do to stay healthy.

Name six healthy habits

2.  3. 
4.  5. 
6.  7. 

Put ✓ for healthy food and X for non healthy foods

- |               |                          |               |                          |
|---------------|--------------------------|---------------|--------------------------|
| 8. Sweets     | <input type="checkbox"/> | 14. Grapes    | <input type="checkbox"/> |
| 9. Mango      | <input type="checkbox"/> | 15. Biscuits  | <input type="checkbox"/> |
| 10. Ice cream | <input type="checkbox"/> | 16. Spinach   | <input type="checkbox"/> |
| 11. Apple     | <input type="checkbox"/> | 17. Chocolate | <input type="checkbox"/> |
| 12. Cakes     | <input type="checkbox"/> | 18. Carrots   | <input type="checkbox"/> |
| 13. Milk      | <input type="checkbox"/> |               |                          |

PARENT'S / GUARDIAN'S SIGN: \_\_\_\_\_

DATE: \_\_\_\_\_

# GRADE 1 APRIL HOLIDAY HOMEWORK 2020

## ALL SUBJECTS

Draw, name and colour the fruits we eat.

19.	20.	21.
22.	23.	

24. We brush our teeth with a \_\_\_\_\_ and 25. \_\_\_\_\_

26. I use \_\_\_\_\_ and 27. \_\_\_\_\_ to wash my hands.

28. What colour is your teeth? \_\_\_\_\_.

29. Draw a tooth

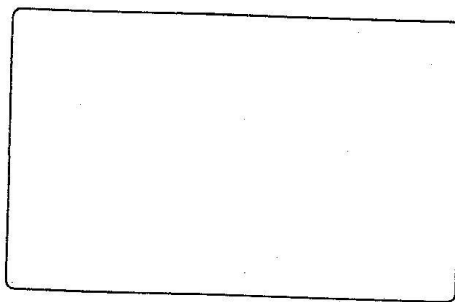





PARENT'S / GUARDIAN'S SIGN: \_\_\_\_\_

DATE: \_\_\_\_\_

# GRADE 1 APRIL HOLIDAY HOMEWORK 2020

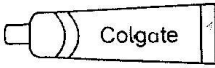
## ALL SUBJECTS

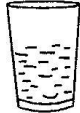
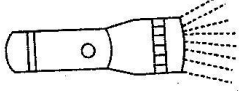
30. I must keep myself \_\_\_\_\_ always (clean, dirty)

31.  _____	32.  _____	33.  _____
34.  _____	35.  _____	

(glass of water, toothbrush, salt, toothpaste, chewed stick)

Write the healthy habits you know

- 36. \_\_\_\_\_
- 37. \_\_\_\_\_
- 38. \_\_\_\_\_
- 39. \_\_\_\_\_
- 40. \_\_\_\_\_
- 41. \_\_\_\_\_
- 42. \_\_\_\_\_

PARENT'S /GUARDIAN'S SIGN: \_\_\_\_\_

DATE: \_\_\_\_\_

# GRADE 1 APRIL HOLIDAY HOMEWORK 2020

## ALL SUBJECTS

Write what we need when we bathe

soap	towel
sugar	chair
water	book
carpet	sponge

43. \_\_\_\_\_

44. \_\_\_\_\_

45. \_\_\_\_\_

46. \_\_\_\_\_

Match the following items to their use

47.	comb	cutting nails
48.	handkerchief	cleaning nose
49.	towel	combing hair
50.	nail cutter	drying the body

51. We wash our hands \_\_\_\_\_ eating.  
(before, after)

52. \_\_\_\_\_ is a place where we relieve ourselves.  
(house, toilet)

53. The falling of teeth in children is called \_\_\_\_\_ of  
teeth  
(falling, shedding)

PARENT'S / GUARDIAN'S SIGN: \_\_\_\_\_

DATE: \_\_\_\_\_

# GRADE 1 APRIL HOLIDAY HOMEWORK 2020

## ALL SUBJECTS

54. A child has \_\_\_\_\_ milk teeth.  
(20, 18)

Name the types of medicine

capsules	syrups
cups	nose drops
tablets	oil
papers	ointment cream
inhaler	

55. \_\_\_\_\_

58. \_\_\_\_\_

56. \_\_\_\_\_

59. \_\_\_\_\_

57. \_\_\_\_\_

60. \_\_\_\_\_

58. \_\_\_\_\_

Match

61. 

Tablets

62. 

Inhaler

63. 

Capsules

64. 

Syrup

PARENT'S / GUARDIAN'S SIGN: \_\_\_\_\_

DATE: \_\_\_\_\_

# GRADE 1 APRIL HOLIDAY HOMEWORK 2020

## ALL SUBJECTS

65. We should take tablets using \_\_\_\_\_ water.  
(clean, dirty)

### Write true or false

66. Milk teeth shedding starts at 6 years \_\_\_\_\_

67. Expired medicine is safe to use. \_\_\_\_\_

68. When we don't have toothpaste, we can use salt. \_\_\_\_\_

69. It is healthy to drink clean and safe water \_\_\_\_\_

70. When we bathe, we use a dirty towel to dry ourselves.  
\_\_\_\_\_

71. It is healthy to sleep well \_\_\_\_\_

### Match

	<u>Name</u>	<u>Where it is used</u>
72.	toothbrush	face
73.	towel	the whole body
74.	ear bud	teeth and tongue
75.	water	wiping nose
76.	handkerchief	inside ears

PARENT'S / GUARDIAN'S SIGN: \_\_\_\_\_

DATE: \_\_\_\_\_

# GRADE 1 APRIL HOLIDAY HOMEWORK 2020

## ALL SUBJECTS

Circle three things we use when we visit the toilet

stones	water	toilet paper
soap	cloth	

80. A clean body smells \_\_\_\_\_ (bad, good)
81. We should keep medicine away from \_\_\_\_\_  
(children, teacher)

82.  This means take one spoon of syrup \_\_\_\_\_ times a day. (2, 3)

Circle common medicine and colour

b	o	l	n	t	m	e	n	t
c	t	c	a	b	j	l	l	s
n	a	a	c	d	e	k	n	y
o	b	p	e	f	a	l	h	r
s	l	s	g	h	r	m	a	u
c	e	u	y	e	d	r	l	p
a	t	l	x	v	r	s	e	s
p	s	e	y	w	o	t	r	z
s	e	s	u	s	p	a	s	a

83. syrups
84. eyedrop
85. inhalers
86. tablets
87. capsules
88. ointment

PARENT'S / GUARDIAN'S SIGN: \_\_\_\_\_

DATE: \_\_\_\_\_

# GRADE 1 APRIL HOLIDAY HOMEWORK 2020

## ALL SUBJECTS

89. We must wash our hands \_\_\_\_\_ visiting the toilet.  
(after, before)

Put ✓ to show good for teeth and X to show not good for teeth

90. ice cream

91. apples

92. chocolates

93. carrots

94. biscuits

95. sweets

96. potatoes

97. A child should gurgle salty water after shedding teeth to \_\_\_\_\_ bleeding  
(speed up, stop)

98. The medicine that we take using a spoon is \_\_\_\_\_  
(syrup, tablets)

99. c\_\_ps\_\_les

100. inh\_\_lers

PARENT'S / GUARDIAN'S SIGN: \_\_\_\_\_

DATE: \_\_\_\_\_



# GRADE 1 APRIL HOLIDAY HOMEWORK 2020

## ALL SUBJECTS

### SHUGHULI ZA KISWAHILI

Tumia rangi kulinganisha salamu na jibu lake.

1. habari njema
2. hamjambo marahaba
3. shikamoo nzuri
4. u hali gani hatujambo

Chora na upake rangi vitu hivi

5. penseli	6. kifutio	7. ubao
8. kitabu	9. rula	10. chupa

SAHIHI YA MZAZI /MLEZI: \_\_\_\_\_ TAREHE: \_\_\_\_\_

# GRADE 1 APRIL HOLIDAY HOMEWORK 2020

## ALL SUBJECTS

### Unganisha silabi hizi ili kuunda maneno

11. ki fu ti o - \_\_\_\_\_
12. ka la mu, - \_\_\_\_\_
13. ba ba - \_\_\_\_\_
14. u ba o - \_\_\_\_\_
15. be nde ra - \_\_\_\_\_
16. ke nge le - \_\_\_\_\_
17. ki wa nja - \_\_\_\_\_

### Kamilisha sentensi hizi

18. Jina langu ni \_\_\_\_\_
19. Niko katika gredi ya \_\_\_\_\_
20. Nina umri wa miaka \_\_\_\_\_
21. Ninasoma katika shule ya \_\_\_\_\_
22. Mwalimu wangu anaitwa \_\_\_\_\_
23. Mimi ni \_\_\_\_\_ (mvulana, msichana)

SAHIHI YA MZAZI /MLEZI: \_\_\_\_\_ TAREHE: \_\_\_\_\_

# GRADE 1 APRIL HOLIDAY HOMEWORK 2020

## ALL SUBJECTS

Paka rangi zifuatazo

24. nyekundu

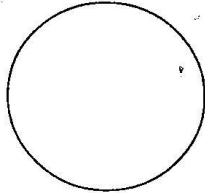

25. manjano

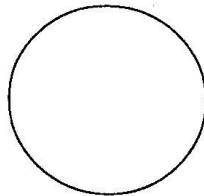

26. buluu

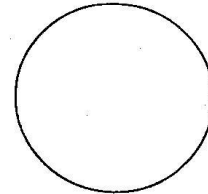

27. kijani

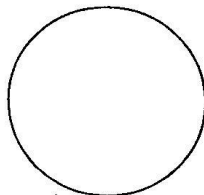

A

Andika nambari hizi kwa maneno

28. 10

\_\_\_\_\_

29. 7

\_\_\_\_\_

30. 5

\_\_\_\_\_

31. 8

\_\_\_\_\_

32. 9

\_\_\_\_\_

Hesabu na ujibu kwa maneno

33. ○○○

\_\_\_\_\_

34. ○○○○○○○

\_\_\_\_\_

SAHIHI YA MZAZI /MLEZI: \_\_\_\_\_ TAREHE: \_\_\_\_\_

# GRADE 1 APRIL HOLIDAY HOMEWORK 2020

## ALL SUBJECTS

35. ○○○○ \_\_\_\_\_

36. ○○ \_\_\_\_\_

### Andika kwa wingi

37. Darasa - \_\_\_\_\_

38. Kiwanja - \_\_\_\_\_

39. Dawati - \_\_\_\_\_

40. Kitabu - \_\_\_\_\_

41. Mwalimu - \_\_\_\_\_

42. Kalamu - \_\_\_\_\_

### Andika herufi kubwa

43. m - \_\_\_\_\_

44. p - \_\_\_\_\_

45. r - \_\_\_\_\_

46. g - \_\_\_\_\_

47. b - \_\_\_\_\_

48. j - \_\_\_\_\_

**SAHIHI YA MZAZI /MLEZI:** \_\_\_\_\_ **TAREHE:** \_\_\_\_\_

# GRADE 1 APRIL HOLIDAY HOMEWORK 2020

## ALL SUBJECTS

---

### Umoja

### Wingi

60. Mguu wangu - \_\_\_\_\_guu yetu
61. Kichwa changu - \_\_\_\_\_chwa vyetu
62. Mkono wangu - \_\_\_\_\_kono yetu
63. Kitabu changu - \_\_\_\_\_tabu vyetu
64. Kiatu changu - \_\_\_\_\_atu vyetu

### Ambatanisha salamu na majibu yao

65. Habari ya asubuhi baba?      Hatujambo mwalimu
66. Hujambo dada?      Marahaba
67. Hamjambo wanafunzi?      Nzuri
68. Shikamoo kaka?      Sijambo

### Andika siku za wiki (69 -75)

69. \_\_\_\_\_      73. \_\_\_\_\_
70. \_\_\_\_\_      74. \_\_\_\_\_
71. \_\_\_\_\_      75. \_\_\_\_\_
72. \_\_\_\_\_
73. \_\_\_\_\_

---

SAHIHI YA MZAZI /MLEZI: \_\_\_\_\_

TAREHE: \_\_\_\_\_

# GRADE 1 APRIL HOLIDAY HOMEWORK 2020

## ALL SUBJECTS

---

76. Kuna siku \_\_\_\_\_ kwa wiki.

### Ambatanisha

77.  mipira sita

78.  chupa tatu

79.  msichana mmoja

80.  saa mbili

### Jaza mapengo

81. mw\_\_limu

82. daft\_\_ri

83. kif\_\_tio

84. Ub\_\_o

85 k\_\_ranja

---

SAHIHI YA MZAZI /MLEZI: \_\_\_\_\_

TAREHE: \_\_\_\_\_

# GRADE 1 APRIL HOLIDAY HOMEWORK 2020

## ALL SUBJECTS

Andika sentensi tano kuhusu "mimi"

86. \_\_\_\_\_
87. \_\_\_\_\_
88. \_\_\_\_\_
89. \_\_\_\_\_
90. \_\_\_\_\_

Unda maneno

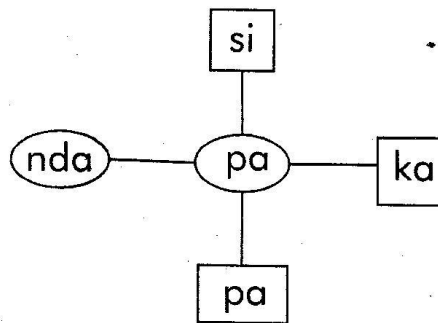

91. \_\_\_\_\_
92. \_\_\_\_\_
93. \_\_\_\_\_
94. \_\_\_\_\_

**SAHIHI YA MZAZI / MLEZI:** \_\_\_\_\_ **TAREHE:** \_\_\_\_\_

# GRADE 1 APRIL HOLIDAY HOMEWORK 2020

## ALL SUBJECTS

### Ambatanisha

- |      |              |    |
|------|--------------|----|
| 95.  | kumi na tisa | 15 |
| 96.  | Kumi na tatu | 17 |
| 97.  | Kumi na nane | 16 |
| 98.  | Kumi na sita | 18 |
| 99.  | Kumi na tano | 19 |
| 100. | Kumi na saba | 13 |

---

SAHIHI YA MZAZI /MLEZI: \_\_\_\_\_

TAREHE: \_\_\_\_\_



# GRADE 1 APRIL HOLIDAY HOMEWORK 2020

## ALL SUBJECTS

### KUSOMA

#### Soma kwa sauti

- |               |               |
|---------------|---------------|
| 1 . rula      | 2 3 . vifaa   |
| 2. kidole     | 2 4. watu     |
| 3. kalamu     | 2 5. salamu   |
| 4 tano        | 2 6 asubuhi   |
| 5. jua        | 2 7. njema    |
| 6. mpira      | 2 8. kati     |
| 7. macho      | 2 9. soma     |
| 8. kitabu     | 3 0. simama   |
| 9. miti       | 3 1. baba     |
| 1 0. kikombe  | 3 2. kifutio  |
| 1 1. nane     | 3 3. ubao     |
| 1 2. mama     | 3 4. penseli  |
| 1 3. vikombe  | 3 5. kabati   |
| 1 4 vidole    | 3 6 chaki     |
| 1 5. mti      | 3 7. meza     |
| 1 6. darasa   | 3 8. begi     |
| 1 7. jina     | 3 9. shule    |
| 1 8. rafiki   | 4 0. umri     |
| 1 9. mwalimu  | 4 1. kucheza  |
| 2 0. kusoma   | 4 2. msichana |
| 2 1. madarasa | 4 3. mvulana  |
| 2 2. hujambo  | 4 4. gredi    |

SAHIHI YA MZAZI /MLEZI: \_\_\_\_\_

TAREHE: \_\_\_\_\_

# GRADE 1 APRIL HOLIDAY HOMEWORK 2020

## ALL SUBJECTS

### Soma kwa sauti

- |                 |                |
|-----------------|----------------|
| 4 5 . mtoto     | 6 3. masikio   |
| 4 6. vitatu     | 6 4. kitanda   |
| 4 7. siku       | 6 5. alhamisi  |
| 4 8 buibui      | 6 6. andika    |
| 4 9. kichwa     | 6 7 . wavulana |
| 5 0. babu       | 6 8. kaka      |
| 5 1. jua        | 6 9. miaka     |
| 5 2. jumatatu   | 7 0 vizuri     |
| 5 3. mwanafunzi | 7 1. pasi      |
| 5 4. kanisa     | 7 2. nne       |
| 5 5 . dada      | 7 3. saa       |
| 5 6. penseli    | 7 4. siku      |
| 5 7. soma       | 7 5. watoto    |
| 5 8. mmoja      | 7 6. duara     |
| 5 9. mkono      | 7 7 . jumapili |
| 6 0. kisani     | 7 8. ulimi     |
| 6 1. cheza      | 7 9. usiku     |
| 6 2. jumatano   |                |

- 8 0 Ninapenda soma la Kiswahili
- 8 1. Ninapenda shule yangu.
- 8 2. Ninapenda kusoma.
- 8 3. Ninapenda mwalimu wangu.
- 8 4. Ninapenda rafiki yangu.

Mimi ni mwanafunzi wa gredi ya kwanza, ninapenda kusoma na kuandika, mwalimu wangu ni mzuri sana. Rafiki yangu anaitwa Beverly. Yeye ni msichana mzuri sana.

SAHIHI YA MZAZI /MLEZI: \_\_\_\_\_

TAREHE: \_\_\_\_\_

# GRADE 1 APRIL HOLIDAY HOMEWORK 2020

## ALL SUBJECTS

### ENVIRONMENTAL ACTIVITIES

Draw and colour things found in the sky during the day.

1.	2.
----	----

Draw and colour a weather symbol showing sunny day.

3.



Draw and colour things found in the sky at night

4.	5.	6.
----	----	----





**PARENT'S / GUARDIAN'S SIGN:** \_\_\_\_\_

**DATE:** \_\_\_\_\_

# GRADE 1 APRIL HOLIDAY HOMEWORK 2020

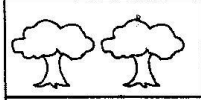
## ALL SUBJECTS

Match the symbols and their names.

7.		Rainy
8.		Cloudy
9.		Sunny
10.		Calm
11.		Windy

Put ✓ for things found in the sky during the day and put X for things found in the sky at night.

12.	Sun	
13.	Moon	
14.	Stars	

15. When somebody rests under shade the weather is \_\_\_\_\_

16. Kites fly well on a \_\_\_\_\_ day.

17. We use an umbrella on a \_\_\_\_\_ day.

18. We put on \_\_\_\_\_ clothes on a cold day.

**PARENT'S / GUARDIAN'S SIGN:** \_\_\_\_\_ **DATE:** \_\_\_\_\_

# GRADE 1 APRIL HOLIDAY HOMEWORK 2020

## ALL SUBJECTS

Draw and name six sources of water

19.	20.	21.	22.
23.	24.		

Fill in the gaps

25. The sky is \_\_\_\_\_ colour.
26. Places we get water from are called \_\_\_\_\_ of water  
(sources, uses.)
27. A \_\_\_\_\_ is not a source of water.  
(river, tap)
28. When we feel thirsty we \_\_\_\_\_ water.

Circle and colour red to show uses of water.

cooking	playing	rubbing
singing	drinking	watering
washing	bathing	

PARENT'S / GUARDIAN'S SIGN: \_\_\_\_\_ DATE: \_\_\_\_\_

# GRADE 1 APRIL HOLIDAY HOMEWORK 2020

## ALL SUBJECTS

34. Circle and colour green the words that describes weather.

windy	sun	weather
trees	rainy	cloudy
clouds	sunny	calm

39. Winnowing is best done on a \_\_\_\_\_ day

On which day do we use them?

40. Umbrella	41. Gumboots	42. Raincoat

43. \_\_\_\_\_ is an underground source of water.

44. We need \_\_\_\_\_ to live.

45. We should turn the tap \_\_\_\_\_ after use.  
(off, borehole, water)

Write true or false

46. A tap is a source of water \_\_\_\_\_

47. Don't turn off the tap after use \_\_\_\_\_

48. Drinking water is a use of water \_\_\_\_\_

PARENT'S / GUARDIAN'S SIGN: \_\_\_\_\_ DATE: \_\_\_\_\_

# GRADE 1 APRIL HOLIDAY HOMEWORK 2020

## ALL SUBJECTS

---

49. Rain is a source of water \_\_\_\_\_

50. River is not a source of water \_\_\_\_\_

Fill the gaps

51. r\_\_iny

52. cl\_\_udy

53. su\_\_nny

54. w\_\_ndy

Use the list below to answer to fill the table

- |                |          |          |
|----------------|----------|----------|
| river          | bathing  | sea      |
| well           | rain     | pond     |
| washing        | lake     | cooking  |
| ocean          | drinking | borehole |
| watering plant |          |          |

Sources of water		Uses of water	
55.		63.	
56.		64.	
57.		65.	
58.		66.	
59.		67.	
60.			
61.			
62.			

**PARENT'S / GUARDIAN'S SIGN:** \_\_\_\_\_

**DATE:** \_\_\_\_\_

# GRADE 1 APRIL HOLIDAY HOMEWORK 2020

## ALL SUBJECTS

---

Write three types of soil

68. \_\_\_\_\_

69. \_\_\_\_\_

70. \_\_\_\_\_

71. The soil used to make pots is \_\_\_\_\_ soil.

72. Loam soil is good for growing \_\_\_\_\_

73. Houses are built using \_\_\_\_\_ soil.  
(sand, crops, clay)

Write true or false

74. Plants give us food. \_\_\_\_\_

75. Plants make our environment beautiful. \_\_\_\_\_

76. We should cut down trees. \_\_\_\_\_

77. All plants are small. \_\_\_\_\_

78. Some plants produces beautiful flowers. \_\_\_\_\_

Write three big plants

79. \_\_\_\_\_

80. \_\_\_\_\_

81. \_\_\_\_\_

PARENT'S / GUARDIAN'S SIGN: \_\_\_\_\_

DATE: \_\_\_\_\_



# GRADE 1 APRIL HOLIDAY HOMEWORK 2020

## ALL SUBJECTS

Write three small plants

82. \_\_\_\_\_

83. \_\_\_\_\_

84. \_\_\_\_\_

Draw the pictures of the animals

85. Cow	86. Sheep	87. Dog
88. Goat	89. Hen	90. Cat

Name four domestic animals

91. \_\_\_\_\_

92. \_\_\_\_\_

93. \_\_\_\_\_

94. \_\_\_\_\_

PARENT'S / GUARDIAN'S SIGN: \_\_\_\_\_

DATE: \_\_\_\_\_

# GRADE 1 APRIL HOLIDAY HOMEWORK 2020

## ALL SUBJECTS

---

Fill the gaps to write big animals

95. eleph\_\_nt

96. li\_\_n

97. leop\_\_ \_\_d

Fill the gaps to write the small animals

98. sn\_\_ke

99. f\_\_sh

100. tort\_\_ise

PARENT'S / GUARDIAN'S SIGN: \_\_\_\_\_

DATE: \_\_\_\_\_

# GRADE 1 APRIL HOLIDAY HOMEWORK 2020

## ALL SUBJECTS

### CHRISTIAN RELIGIOUS ACTIVITIES

1. God knows me by my \_\_\_\_\_
2. My name is \_\_\_\_\_
3. I am \_\_\_\_\_ years old.
4. I am \_\_\_\_\_ (boy, girl)

Draw, colour and name items we share at home

5.	6.
7.	8.

**PARENT'S / GUARDIAN'S SIGN:** \_\_\_\_\_ **DATE:** \_\_\_\_\_





# GRADE 1 APRIL HOLIDAY HOMEWORK 2020

## ALL SUBJECTS

Draw and colour your family members

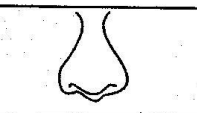
9. Father	10. Mother
11. Sister	12. Brother

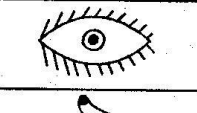
Match correctly and colour them

13.	Hand		
14.	Eye		
15.	Leg		
16.	Nose		
17.	Ear		

**PARENT'S / GUARDIAN'S SIGN:** \_\_\_\_\_ **DATE:** \_\_\_\_\_

# GRADE 1 APRIL HOLIDAY HOMEWORK 2020

## ALL SUBJECTS

---

Draw and colour the following

18. Cross	19. Bible	20. Church
-----------	-----------	------------

Name things we share at home

21. \_\_\_\_\_

22. \_\_\_\_\_

23. \_\_\_\_\_

24. \_\_\_\_\_

25. \_\_\_\_\_

26. When we share, God is \_\_\_\_\_  
(happy, worried)

27. The Bible is the \_\_\_\_\_ of God.

28. We should take \_\_\_\_\_ of the Bible.

29. The Bible is divided into \_\_\_\_\_ testament and  
\_\_\_\_\_ testament.

30. I should be \_\_\_\_\_ when the Bible is read.  
(speaking, quiet)

---

PARENT'S / GUARDIAN'S SIGN: \_\_\_\_\_ DATE: \_\_\_\_\_

# GRADE 1 APRIL HOLIDAY HOMEWORK 2020

## ALL SUBJECTS

31. We should \_\_\_\_\_ before reading the Bible.  
(pray, sleep)

Circle and colour these words

b	l	b	l	e	y	x	c	b	y
r	q	c	w	p	x	a	m	o	x
e	u	l	o	r	e	a	d	o	s
s	n	e	w	a	x	y	n	k	t
p	e	a	d	y	d	c	e	y	a
e	t	n	k	b	o	o	w	c	n
c	o	b	e	y	k	c	m	k	d
t	o	l	d	t	a	n	d	d	e

32. read

33. bible

34. pray

35. respect

36. clean

37. book

38. stand

39. old

40. new

41. \_\_\_\_\_ created animals.

42. Wild animals stay in the \_\_\_\_\_.

43. Domestic animals stay at \_\_\_\_\_.

Fill the gaps to write types of animals

44. d\_\_nkey

45. c\_\_w

46. dom\_\_stic

47. w\_\_ld

48. z\_\_bra

49. l\_\_on

50. sh\_\_ \_\_p

**PARENT'S / GUARDIAN'S SIGN:** \_\_\_\_\_ **DATE:** \_\_\_\_\_

# GRADE 1 APRIL HOLIDAY HOMEWORK 2020

## ALL SUBJECTS

51. All plants were created by \_\_\_\_\_
52. We get f\_\_\_\_\_d from plants.
53. When the weather is sunny we rest under a tree because it gives us \_\_\_\_\_. (food, shade)
54. Children have different \_\_\_\_\_. (abilities, colours)
55. We should \_\_\_\_\_ young plants. (cut, water)
56. We should be \_\_\_\_\_ to animals.  
(kind, harsh)

Write domestic or wild animals using the list

Zebra, cow, lion, donkey, sheep,  
goat, elephant, dog, cat, pig,  
giraffe.

Domestic	Wild
57. _____	64. _____
58. _____	65. _____
59. _____	66. _____
60. _____	67. _____
61. _____	
62. _____	
63. _____	

PARENT'S / GUARDIAN'S SIGN: \_\_\_\_\_

DATE: \_\_\_\_\_

# GRADE 1 APRIL HOLIDAY HOMEWORK 2020

## ALL SUBJECTS

68. I am \_\_\_\_\_ before God (rejected, special)

69. We should not \_\_\_\_\_ papers from the Bible.  
(cut, put)

70. God speaks to us through the \_\_\_\_\_  
(children, Bible)

71. I should pray \_\_\_\_\_ (once, always)

### Draw God's creations and colour

72. Moon	73. Star	74. Sun
----------	----------	---------

### Draw and colour parents

75. Father	76. Mother
------------	------------

PARENT'S / GUARDIAN'S SIGN: \_\_\_\_\_ DATE: \_\_\_\_\_



# GRADE 1 APRIL HOLIDAY HOMEWORK 2020

## ALL SUBJECTS

77. I am a child of \_\_\_\_\_  
(God, satan)

78. \_\_\_\_\_ flowers is a way of taking care of God's  
creation. (sweeping, watering)

### Fill in the gaps

79. b\_\_ble

83. o\_\_d

80. cre\_\_tion

84. w\_\_rd

81. t\_\_stament

85. G\_\_d

82. n\_\_w

### The first two books in the new testament are:

86. Math\_\_w

87. M\_\_rk

88. I am \_\_\_\_\_ before God.  
(special, nothing)

### Draw and colour

89. Boy          	90. Girl          
---	--

PARENT'S / GUARDIAN'S SIGN: \_\_\_\_\_ DATE: \_\_\_\_\_

# GRADE 1 APRIL HOLIDAY HOMEWORK 2020

## ALL SUBJECTS

A family is made up of

91. f\_\_th\_\_r

92. m\_\_th\_\_r

93. s\_\_st\_\_r

94. br\_\_th\_\_r

95. God made me to look like \_\_\_\_\_  
(Himself, someone else)

Match

- |           |          |
|-----------|----------|
| 96. mouth | smelling |
| 97. legs  | hearing  |
| 98. eyes  | talking  |
| 99. ears  | walking  |
| 100. nose | seeing   |

PARENT'S / GUARDIAN'S SIGN: \_\_\_\_\_ DATE: \_\_\_\_\_

# GRADE 1 APRIL HOLIDAY HOMEWORK 2020

## ALL SUBJECTS

---

### ISLAMIC RELIGIOUS ACTIVITIES

1. My name is \_\_\_\_\_
2. I am a \_\_\_\_\_  
(Muslim, Christian, non-muslim)
3. The name of our God is \_\_\_\_\_  
(Elloa, Shallom, Allah)
4. Muhammad is our \_\_\_\_\_  
(Father, Prophet, Angel)
5. \_\_\_\_\_ is a muslim.  
(Hassan, Samuel, John)
6. \_\_\_\_\_ is NOT a muslim.  
(Aisha, Fatuma, Mary)
7. Muslims should be called \_\_\_\_\_  
(any name, good names, bad names)
8. \_\_\_\_\_ made all my body parts.  
(Allah, Prophet, Angel)
9. I \_\_\_\_\_ Allah for giving me parts of my body.  
(wish, curse, thank)
10. I have one \_\_\_\_\_ on my body.  
(eye, mouth, leg)

---

PARENT'S/GUARDIAN'S SIGN: \_\_\_\_\_ DATE: \_\_\_\_\_

# GRADE 1 APRIL HOLIDAY HOMEWORK 2020

## ALL SUBJECTS

Match these body parts with what they do.

- 1 1. Eyes for smelling
- 1 2. Nose for catching
- 1 3. Ears for walking
- 1 4. Hands for seeing
- 1 5. Legs for hearing
- 1 6. \_\_\_\_\_ is in our small family.  
(Sister, Cousin, Uncle)
- 1 7. The head of our family is \_\_\_\_\_  
(mother, father, brother)
- 1 8. \_\_\_\_\_ are member of our big family.  
(Relatives, Neighbours, Friends)
- 1 9. I \_\_\_\_\_ my family members.  
(hate, punish, love)
20. When I meet people I first \_\_\_\_\_ them.  
(wave at, follow, greet)
- 2 1. Us muslims greet by saying \_\_\_\_\_  
(Asslaam Aleikum, Allah Akbar, Qul huwallahu Ahad)
22. We greet to wish \_\_\_\_\_, mercy and blessings of Allah.  
(unity, love, peace)
23. In your language you greet by saying \_\_\_\_\_

---

PARENT'S/GUARDIAN'S SIGN: \_\_\_\_\_ DATE: \_\_\_\_\_

# GRADE 1 APRIL HOLIDAY HOMEWORK 2020

## ALL SUBJECTS

24. I thanked Laila for her help. I said \_\_\_\_\_ to her.  
(Marhaba, Mashallah, Shukran)
25. It is a polite language to say “ \_\_\_\_\_ ”  
(excuse me, go away, shame on you)
26. We thank Allah by saying \_\_\_\_\_  
(Bismillah, Alhamdulillah, Wallahi)
27. A muslim should \_\_\_\_\_ another muslim.  
(abuse, curse, advice)
28. People who do good things will enter \_\_\_\_\_  
(paradise, heaven, skys)
29. \_\_\_\_\_ brought all people to live on earth.  
(President, Allah, Prophet)
30. Things that we have and what we eat is our \_\_\_\_\_  
(rizik, brains, efforts)
31. Donkeys and camels help us with \_\_\_\_\_  
(milk, transport, digging)
32. We drink the \_\_\_\_\_ of a cow.  
(juice, porridge, milk)
33. The juice of a \_\_\_\_\_ is very sweet.  
(pineapple, cabbage, potatoes.)

---

**PARENT'S/GUARDIAN'S SIGN:** \_\_\_\_\_ **DATE:** \_\_\_\_\_



# GRADE 1 APRIL HOLIDAY HOMEWORK 2020

## ALL SUBJECTS

Draw these creatures of Allah

34. The sun	35. The stars
36. moon	37. A river

Name these creatures of Allah

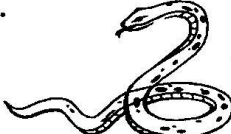
38. 	39. 	40. 
--	--	---





- 4 1. Each finger on our hand is divided into \_\_\_\_\_ parts.  
(two, three, four)
- 4 2. The BEST food I like is \_\_\_\_\_
- 4 3. \_\_\_\_\_ created everything.  
(Allah, Angels, Jinns)
- 4 4. Muslims \_\_\_\_\_ Allah along.  
(see, sing to, worship)
- 4 5. Our holy book is Qur'an \_\_\_\_\_  
(Adhwim, Karim, Ramadhan)

PARENT'S/GUARDIAN'S SIGN: \_\_\_\_\_ DATE: \_\_\_\_\_

# GRADE 1 APRIL HOLIDAY HOMEWORK 2020

## ALL SUBJECTS

### Match these sounds

- 4 6.  sha
- 4 7.  ka
- 4 8.  ya
- 4 9.  ta
- 5 0.  a

### Tick correct ( ✓ ) and wrong ( X ) about a good muslim.

- 5 1. A good muslim does not fight
- 5 2. A good muslim does not pray
- 5 3. A good muslim does not annoy others
- 5 4. A good muslim does not greet people
- 5 5. A good muslim does not quarrel others
- 5 6. We should \_\_\_\_\_ our parents. (respect, hate, disturb)
- 5 7. There are \_\_\_\_\_ pillars of Islam. (Three, six, five)
- 5 8. Muslims \_\_\_\_\_ everyday. (pray Swalah, pay Zakkah, fast Swaum)
- 5 9. Muslims go for Hajja in \_\_\_\_\_  
(Madina, Jerusalem, Makka)
- 6 0. Another name of Kalima is \_\_\_\_\_  
(Tawhid, Shahada, Ahad)

**PARENT'S/GUARDIAN'S SIGN:** \_\_\_\_\_ **DATE:** \_\_\_\_\_